



# SLATTED CLADDING AND TRIMS

Installation Guide,  
Aftercare and FAQs

**CLADCO**  
DECKING



Cladco Slatted Wall Cladding Panels are made from Capped Composite materials and are designed to replicate the natural variants of a slatted Timber Cladding board. It is therefore recommended that you purchase all Slatted Cladding Boards required for the same project, together at the same time, as this will ensure there is minimal colour variation in the Boards – whilst saving any additional delivery costs.

We advise that all Slatted Cladding Boards are laid out prior to installation to ensure a natural, balanced colour tone across all the Panels. As with all materials exposed to direct sunlight, some natural weathering may occur over time.

Slatted Wall Cladding Panels can be installed on multiple wall types, as well as around windows, doors and wall corners provided the correct substructure and Trims are used. We advise working with your builder or joiner prior to installation to ensure all Trims required are correctly accounted for at the time of ordering.



## STORAGE AND HANDLING

Cladco Slatted Wall Cladding Panels should always be stored in a cool and dry place that is out of direct sunlight. They should be stored on a level surface that supports the entire length of the Board - ensuring they do not warp or bend.

Protective gloves must be worn when handling or cutting the Slatted Cladding Panels, and care must be taken when lifting. We recommend a minimum of two persons carry the Panels and install the panels, always ensuring it is within their physical capabilities.

Please note this is a guide and not a definitive explanation of how to install slatted cladding.

# TOOLS

---



## Protective Equipment

When handling or carrying Cladco Slatted Cladding Boards it is advised to wear long sleeves and gloves. When cutting the Boards, we suggest you wear a protective dust mask, ear defenders and safety glasses.



## Tool Set

Standard everyday DIY or carpentry tools such as a tape measure, spirit level, pencil and Stanley knife.



## Cutting Tools

Slatted Wall Cladding Boards can be cut using any standard wood cutting tools. We recommend using a fine-toothed blade to get the cleanest finish to your cut edge.



## Power Drill Or Driver:

Standard power drills can be used when installing Slatted Wall Cladding Boards.

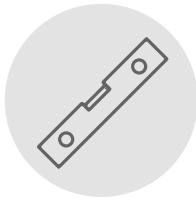

## Spirit Level

A spirit level is essential when installing your Battens to ensure a level support system.

# DO'S & DON'TS



Do not install Slatted Wall Cladding if the Boards, building or the surrounding areas are wet



Do not cut the Slatted Wall Cladding Boards indoors



Do not dry sweep dust or debris off the Boards, as it may cause the particles to enter the air and could be inhaled - wipe away with a damp cloth



Always follow the tool manufacturer's safety recommendations when using saws or other machinery

## PREPARING THE WALL

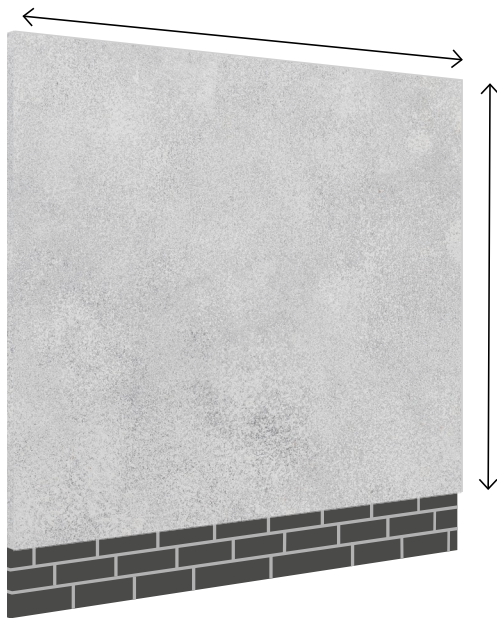

### STEP 1: MEASURE

Prior to installation, it is important to review the overall layout of your battens to ensure appropriate support to your Slatted Cladding Boards. Take into consideration the design of each section, especially for the following:

- Where Cladding Boards meet at a butt end, two battens are needed to create a double joist.
- Consider features of your wall such as windowsills, door frames, soffits and drainpipes. Sufficient batten support must be installed to accommodate these areas, refer to the Trims illustration on page 8 for further information.

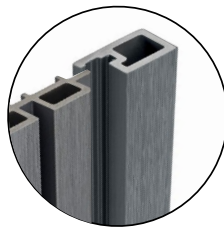

- Slatted Cladding Panels have a tongue and groove effect and so if you are looking to use Trims, these must be calculated in line with the direction of the Slatted Panels beforehand.



**TOP TIP Temperature Changes:** Extreme temperature changes could cause the Boards to expand or contract. Ensure Boards have had sufficient time to acclimatise to the outside temperature before installing. Do not install in extreme temperatures.

# VERTICAL INSTALLATION

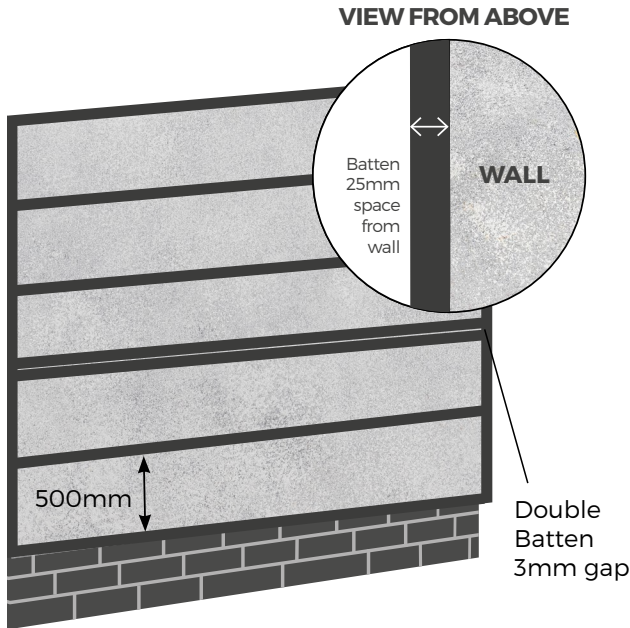

## STEP 1: BATTENS

It is recommended that you use either 30mm x 50mm Cladco Composite Battens or 50mm x 25mm timber battens as a supportive sub-structure to install your Slatted Cladding Panels upon. Cladco Composite Battens help to maximise the long-term performance of your Cladding. Timber battens will also support your Cladding following the same installation process as Composite Battens.

You will need to pre-drill the Battens and the surface below that it will be fixed upon. Using a 6mm drill bit, ensure the Battens are secured at least 50mm into the below surface. You will therefore need to use screws and fixings that are suitable for the surface you are fixing into, and screws should be at least 80mm long to accommodate the width of the batten and the 50mm drilling space below the surface.

For a vertical installation, Battens should be fastened horizontally to a flat and stable surface with a minimum distance of 500mm between each Batten. They will need to run the entire width of the area being clad. You may need to install more Battens where two Panels join, ensuring there is at least a 5mm expansion gap between each Batten. This is because each Panel will need to be supported on a Batten where it meets the next Panel. Remember to install your Battens at a 90-degree angle to the way you want your wall Cladding Panels to run.

It is recommended that you edge your Battens around the perimeter to create a Batten frame, this is to ensure that once fully installed, there is no visible gap between the Panel and the Wall, and will also prevent debris and small animals/ insects from entering the underside.

## DOUBLE BATTENS

Install Double Battens where two Panels join, ensuring there is at least a 5mm expansion gap between each Batten. This is because each Panel will need to be supported on an individual Batten where it meets the next Panel.

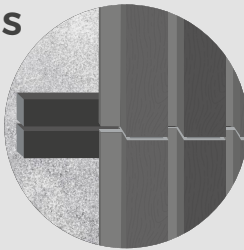

## PRE-DRILL

In order to avoid Slatted Cladding Boards cracking or splitting when being fixed in place, always pre-drill the Boards and Battens.

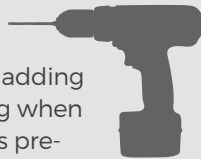

## AIRFLOW

Whilst there is no set requirement for which batten you choose to use to form your Cladding framework, there must always be a minimum gap of 25mm between the wall and the Slatted Cladding Panels, to ensure adequate airflow and ventilation.



# VERTICAL INSTALLATION

## STEP 2: FIXING THE FIRST BOARD

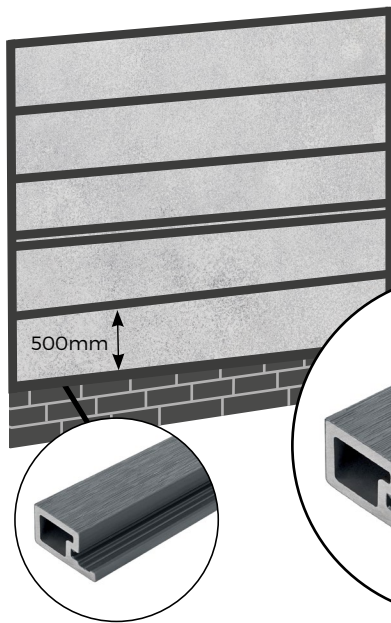

Before the Slatted Cladding Panels can be installed, the Single Start Profile Trims must be fixed in place alongside the Battens before any of the Panels can be installed using 20mm screws. A 5mm expansion gap should be left between the Slatted Panels and the Internal/ External Corner and Double End Profile Trim. It is recommended that each section is fully installed at a time for consistency.

Please note that the Single Start Profile Trims shown here can only be installed on one end of the wall due to the tongue and groove. To ensure your Wall Cladding matches each tongue and groove section throughout, it is recommended that proper measurements are taken prior to purchase. For more information on each Trim and their end use, please see page 8.

## STEP 3: FIXING LEFT TO RIGHT

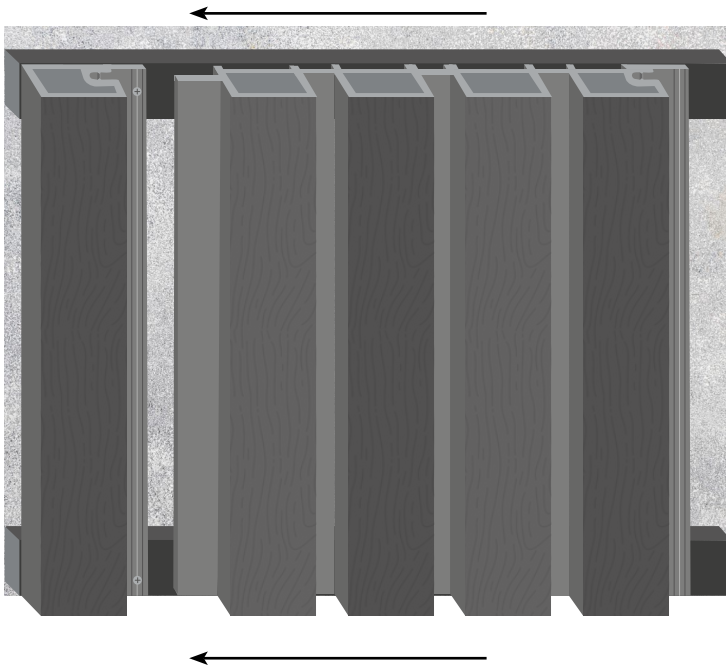

The second Panel can now be slotted next to the first using the tongue and groove method. The non-grooved lip of the second panel will conceal the screws from the first and secured on the top grooved lip. Repeat this process with each Slatted Panel until you reach the required coverage, making sure that each Panel is securely fixed to the Batten underneath.

When installing a Panel next to a Double End Profile Trim, a 5mm expansion gap must sit between the Panel and the Trim face. When installing a Panel next to an Internal or External Corner Trim, a 5-7mm expansion gap should sit between the Panel and the Trim Corner. This is so the Board can sit flush against the Trims and not interrupt the profile. For more information on Slatted Cladding Trims and their uses, take a look at page 8.



**TOP TIP** Where Panels meet end-to-end, it is important that the appropriate expansion gap of at least 5mm is left between Panels, and if two Battens are being used to fix these in place, then they must also be spaced 20mm apart to allow for secure fixing.

# VERTICAL INSTALLATION

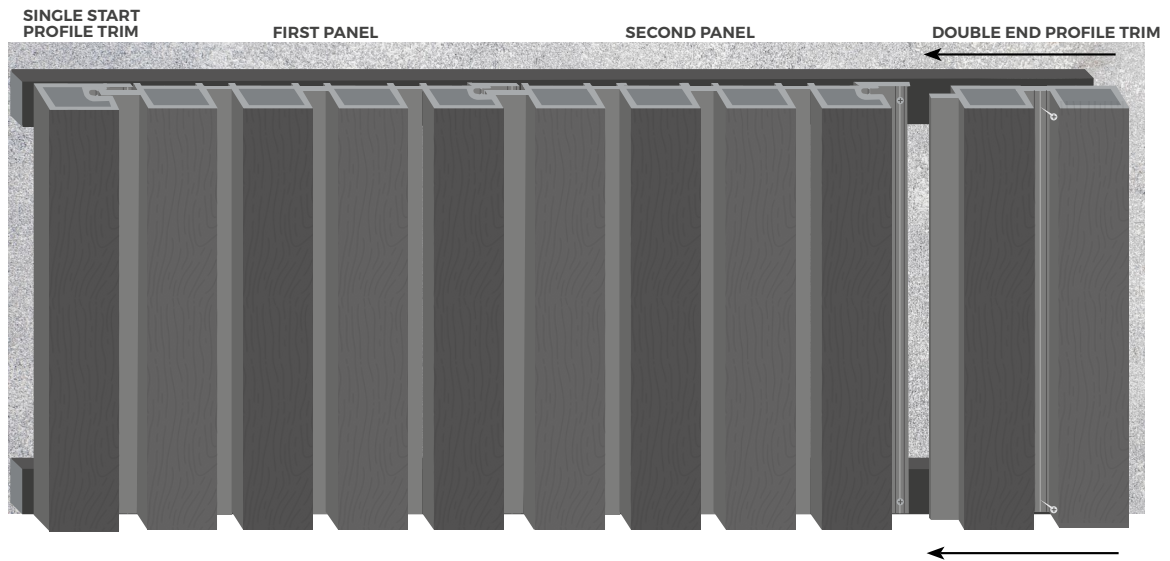

Finish the side edges of your Slatted Wall Cladding installation with a Double End Profile Trim. This is a narrower version of the Panels themselves and neatly finishes a wall end as shown here.

## STEP 4: CORNER TRIM

When it comes to finishing your Slatted Cladding project, you may wish to use a Corner Trim along the top or bottom of your installation for a finish that hides any hollow ends and to avoid water pooling. Please note, if installing corner trims at the bottom of the panel, it is advisable to also install at the top to avoid water becoming trapped in the channels.

Measure the area you wish to cover with the Corner Trim and cut the Trim to size. Pre-drill the Corner Trim and fix securely every 300mm along the length using appropriate screws. When joining one Trim end to another, a minimum gap of 2mm should be left between both ends.

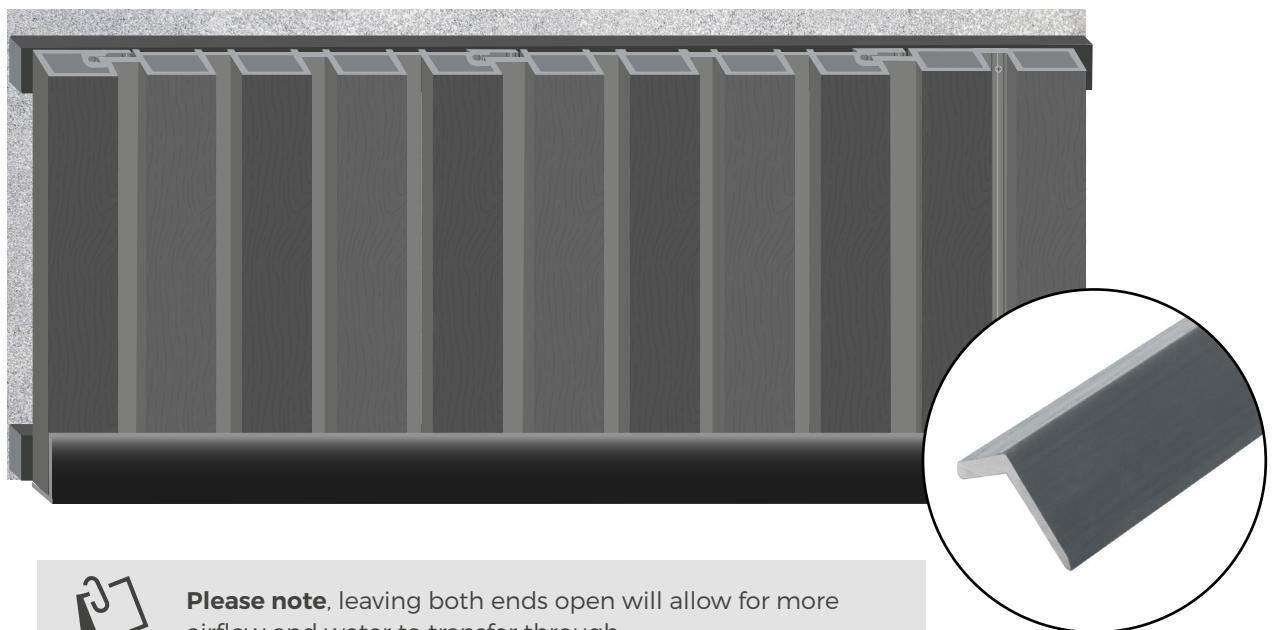

**Please note**, leaving both ends open will allow for more airflow and water to transfer through.

# SLATTED CLADDING TRIMS

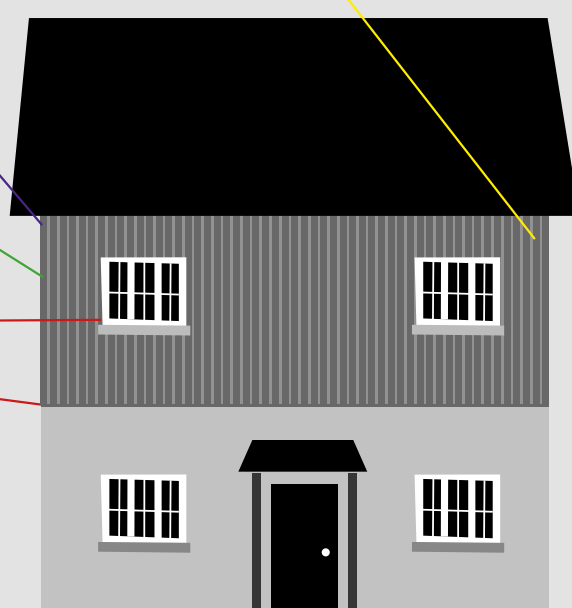

**EXTERNAL CORNER TRIM**  
Designed to fit on the corners of the building, to produce a professional edge.

**DOUBLE END PROFILE TRIMS**  
Fitted along the side edges of your building to finish the length of Slatted Cladding seamlessly.

**SINGLE START PROFILE TRIMS**  
Installed along the side edges to start or finish your Slatted Cladding project.

**CORNER TRIM**  
Installed under the Battens at the base of the installation, or at the top as a finishing edge. Corner Trims conceal any exposed corners or edges and create a neat finish.



**INTERNAL CORNER TRIM**

Secure Slatted Wall Cladding Panels to the inward corners of a building using Internal Corner Trims, manufactured from the same Capped Composite material as our Slatted Panels.

Designed to complete your Cladding project, our Internal Corner Trims sit on top of your batten substructure to allow Slatted Panels to join together. The surface of these Trims features a smooth, plain surface for a professional finish.



**INSTALLATION AROUND WINDOWS**

**Shallow Sunken Windows:** When installing Cladco Slatted Panels around windows, you can use either Corner Trims or Double End Profile Trims. For shallow sunken windows, use Double End Profile Trims joined at the corners at a 45-degree angle, for a picture frame finish along the edges of the window. Slatted Panels can then be laid around the window seamlessly.

**Deep Sunken Windows:** For Windows that are deeper sunken, use a Corner Trim to edge the perimeter of the window. The Slatted Cladding Panel can then be installed adjacent to the Trim.

**IF YOU REQUIRE ADDITIONAL TRIMS AND FIXINGS FOR YOUR PROJECT, PLEASE SPEAK TO OUR ADVISORS FOR ASSISTANCE ON 01837 659901 OR VIA EMAIL - [INFO@CLADCO.CO.UK](mailto:INFO@CLADCO.CO.UK)**



# HORIZONTAL INSTALLATION

Before beginning horizontal installation, please ensure you have read our guide to measuring your wall correctly and features to consider on page four.

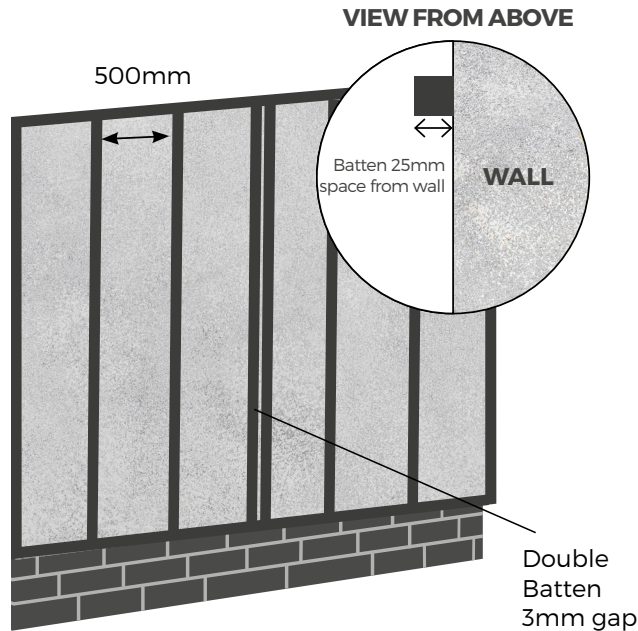

## STEP 1: BATTENS

It is recommended that you use either 30mm x 50mm Cladco Composite Battens or 50mm x 25mm timber battens as a supportive sub-structure to install your Slatted Cladding Panels upon. Cladco Composite Battens help to maximise the long-term performance of your Cladding. Timber battens will also support your Cladding following the same installation process as Composite Battens.

You will need pre-drill the Battens and the surface below that it will be fixed upon. Using a 6mm drill bit, ensure the Battens are secured at least 50mm into the below surface. You will therefore need to use screws and fixings that are suitable for the surface you are fixing into, and screws should be at least 80mm long to accommodate the width of the batten and the 50mm drilling space below the surface.

Battens should be fastened vertically to a flat and stable surface with a minimum distance of 500mm between each Batten. They will need to run the entire length of the area being clad. You may need to install more Battens where two Panels join, ensuring there is at least a 5mm expansion gap between each Batten. This is because each Panel will need to be supported on a Batten where it meets the next Panel. Remember to install your Battens at a 90-degree angle to the way you want your wall Cladding Panels to run.

It is recommended that you edge your Battens around the perimeter to create a Batten frame, this is to ensure that once fully installed, there is no visible gap between the Panel and the Wall, and will also prevent debris and small animals/ insects from entering the underside.

### DOUBLE BATTENS

Install Double Battens where two Panels join, ensuring there is at least a 5mm expansion gap between each Batten. This is because each Panel will need to be supported on an individual Batten where it meets the next Panel.

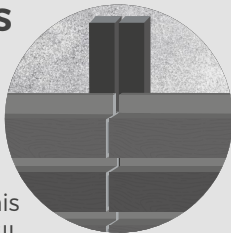

### PRE-DRILL

In order to avoid Slatted Cladding Boards cracking or splitting when being fixed in place, always pre-drill the Boards and Battens.



### AIRFLOW

Whilst there is no set requirement for which batten you choose to use to form your Cladding framework, there must always be a minimum gap of 25mm between the wall and the Slatted Cladding Panels, to ensure adequate airflow and ventilation.



# HORIZONTAL INSTALLATION

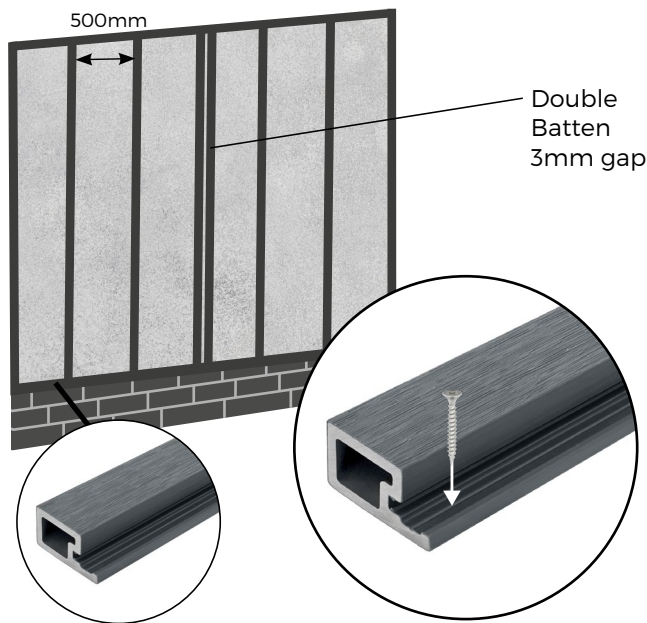

## STEP 2: FIXING THE FIRST BOARD

Before the Slatted Cladding Panels can be installed, the Single Start Profile Trims must be fixed in place alongside the Battens before any of the Panels can be installed using 20mm screws. A 5mm expansion gap should be left between the Slatted Panels and the Internal/ External Corner and Double End Profile Trim. It is recommended that each section is fully measured and installed at a time for consistency.

Please note that the Single Start Profile Trims shown here can only be installed on one end of the wall due to the tongue and grooves. For more information on each Trim and their end use, please see page 12.

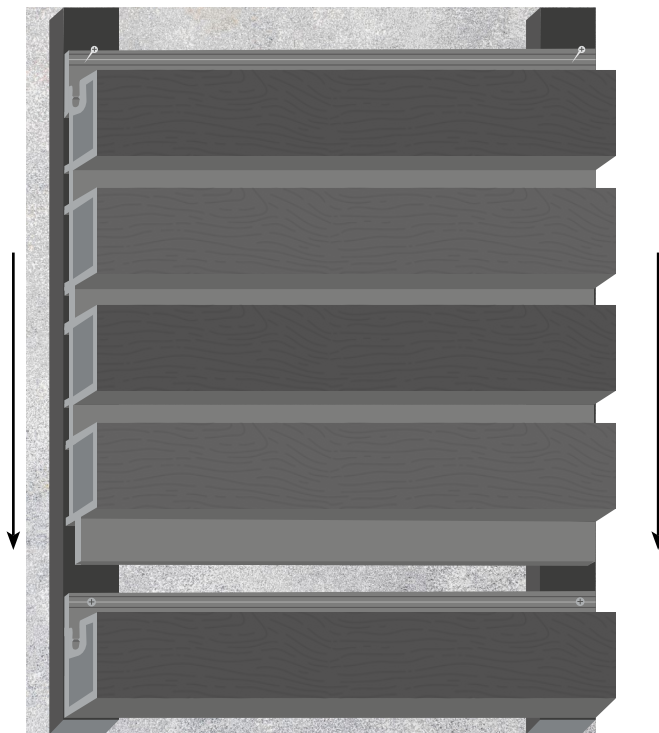

## STEP 3: FIXING BOTTOM TO TOP

Place the first Slatted Cladding Panel Horizontally along the bottom Single Start Profile Trim. Secure the Panel to the Trim using 20mm long Screws.



**TOP TIP** Where Panels meet end-to-end, it is important that the appropriate expansion gap of at least 5mm is left between Panels, and if two Battens are being used to fix these in place, then they must also be spaced 20mm apart to allow for secure fixing.

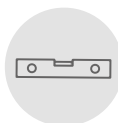

A spirit level is essential when installing your Slatted Cladding to ensure it is completely level.

# HORIZONTAL INSTALLATION

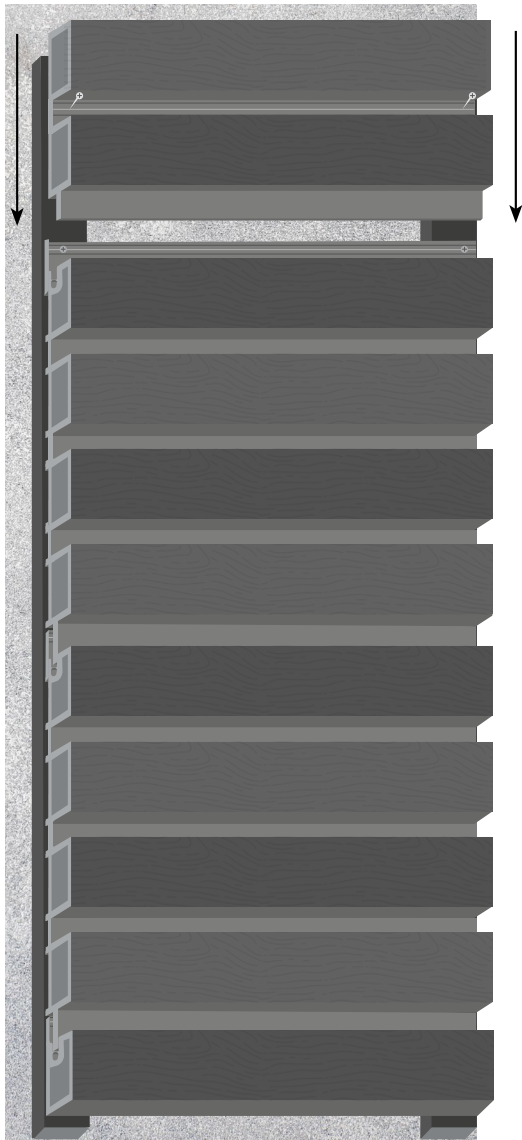

The second Panel can now be slotted on top of the first using the tongue and groove method. The non-grooved lip of the second panel will conceal the screws from the first and secured on the top grooved lip. Repeat this process with each Slatted Panel until you reach the required height and coverage, making sure that each panel is securely fixed to the Batten underneath.

When installing a Panel on top of a Double End Profile Trim, a 5mm expansion gap must sit between the Panel and the Trim face. When installing a Panel on top of an Internal or External Corner Trim, a 5-7mm expansion gap should sit between the Panel and the Trim Corner. This is so the Board can sit flush against the Trims and not interrupt the profile. For more information on Slatted Cladding Trims and their uses, take a look at page 12.

## STEP 4: CORNER TRIM

When it comes to finishing your Slatted Cladding project, you may wish to use a Corner Trim along the edges of your installation for a flush finish that hides any hollow ends.

Measure the area you wish to cover with the Corner Trim and cut the Trim to size. Pre-drill the Corner Trim and fix securely every 300mm along the length using appropriate screws. When joining one Trim end to another, a minimum gap of 2mm should be left between both ends.

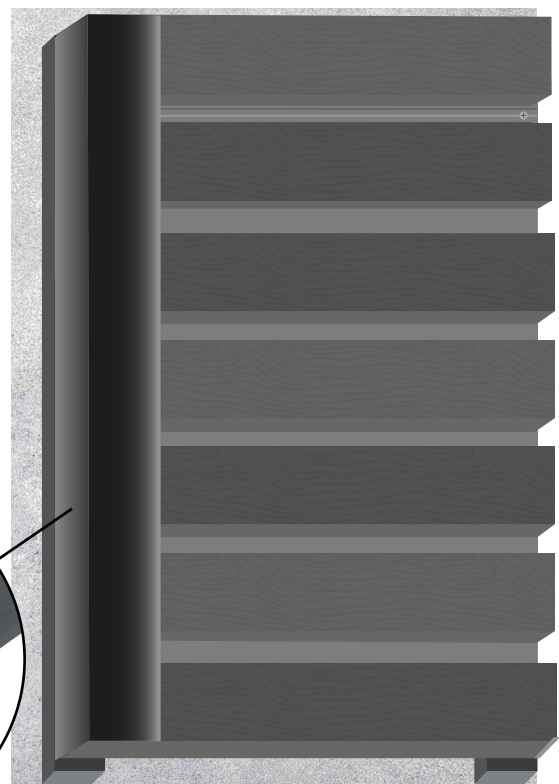
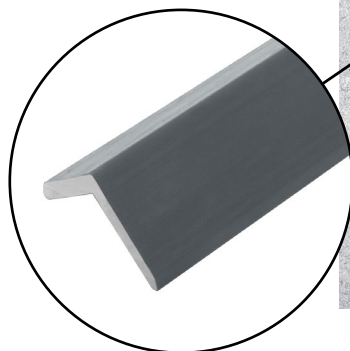

# SLATTED CLADDING TRIMS

## SINGLE START PROFILE TRIMS

Installed along the side edges to start or finish your Slatted Cladding project.

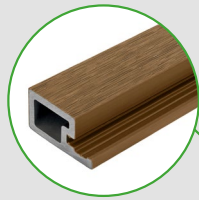

## DOUBLE END PROFILE TRIMS

Fitted along the side edges of your building to finish the length of Slatted Cladding seamlessly.

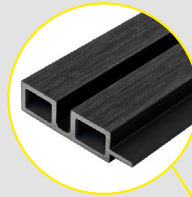

## CORNER TRIM

Installed under the Battens at the base of the installation, or at the top as a finishing edge, Corner Trims conceal any exposed corners or edges and create a neat finish.

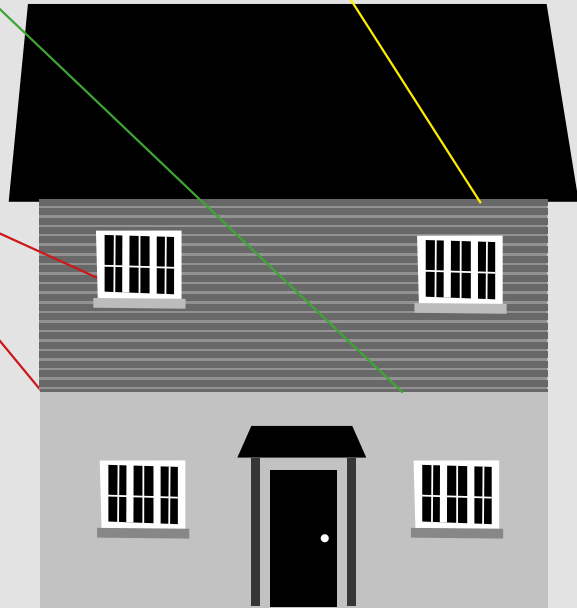
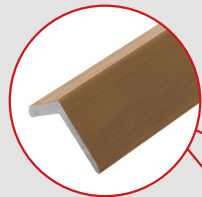

## INSTALLATION AROUND WINDOWS

**Shallow Sunken Windows:** When installing Cladco Slatted Panels around windows, you can use either Corner Trims or Double End Profile Trims. For shallow sunken windows, use Double End Profile Trims joined at the corners at a 45-degree angle, for a picture frame finish along the edges of the window. Slatted Panels can then be laid around the window seamlessly.

**Deep Sunken Windows:** For Windows that are deeper sunken, use a Corner Trim to edge the perimeter of the window. The Slatted Cladding Panel can then be installed adjacent to the Trim.

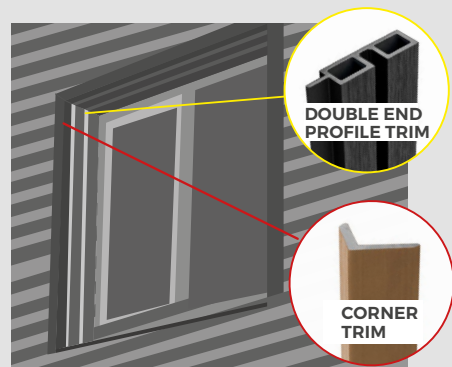

**IF YOU REQUIRE ADDITIONAL TRIMS AND FIXINGS FOR YOUR PROJECT, PLEASE SPEAK TO OUR ADVISORS FOR ASSISTANCE ON 01837 659901 OR VIA EMAIL - [INFO@CLADCO.CO.UK](mailto:INFO@CLADCO.CO.UK)**

# AFTERCARE

---

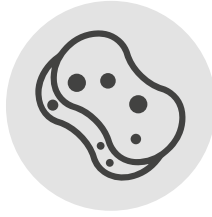

## MAINTENANCE

Ensure your Panels are kept clear of debris and dirt by cleaning with lukewarm or cold water. A mild, household dish soap can be added for more stubborn stains such as bird droppings.

Ensure the Boards are kept clean of dirt, pollution and other stains by checking them annually and giving them a quick clean when necessary.

Important – Do not use high-pressured cleaning systems on Cladco Slatted Cladding as this may cause damage to the paint and finish of the Panels.



# FREQUENTLY ASKED QUESTIONS

---

## Where can I install my Slatted Cladding Panels?

Slatted Wall Cladding Panels can be installed on any exterior surface with the correct supporting structure including garages, sheds, houses, or garden rooms.

## Can I use a pressure washer?

Pressure washers are not recommended to be used on Cladco Slatted Wall Cladding as the pressure could strip the Panels of their paint layers and properties.

Simply clean using lukewarm or cold water and light detergent with a cloth or soft brush.

## Do I need planning permission to put my Wall Cladding up?

In most cases, adding Cladding to your home does not require planning permission, providing that the materials are off a similar appearance to the rest of your home. In some cases, you may need to apply for planning permission if your home is a listed building in an area of exceptional beauty or a national park. Please note that we are not licensed planning or building surveyors. We recommend speaking to a licensed professional.

## Can Cladco Slatted Wall Cladding Panels be installed horizontally?

Cladco Slatted Cladding Panels can be installed horizontally as well as vertically.

For horizontal installations, the joists and battens will need to be installed vertically (the opposite orientation to the Panels), however the installation method remains the same whichever direction you wish to install your Cladding.

## Can Cladco Slatted Wall Cladding Panels be painted?

Cladco Slatted Wall Cladding Panels are available in a variety of six attractive colours. Their low-maintenance composite material does not need to be sanded, treated or varnished. Simply select your chosen colour, install and enjoy. Please note, Cladco Slatted Wall Cladding Panels cannot be painted.

## Are the Panels scratch resistant?

Cladco Slatted Wall Cladding Panels have increased scratch resistance when compared with natural Timber. This is due to their unique Capped Composite material which increases the Panels' durability and should not scratch, or mark easily. Boards may still scratch if handled incorrectly.

## Can I cut my Slatted Cladding Panels down to size?

You can cut your Slatted Cladding Panels widthways to amend the length using any standard wood cutting tools. We recommend using a fine-toothed blade to get the cleanest finish to your cut edge.

Please note that if cutting your Panels lengthways to alter the width, you will lose the interconnecting tongue and groove parts and therefore cannot attach another trim or board to it.

## What colours are available?



## Can I order a Sample?

Cladco Slatted Wall Cladding Samples can be ordered via the website, or by contacting our friendly sales team on 01837 659901.

You can choose two of the six available colours to sample. The Sample swatches come with a Cladco Decking Brochure and a Price List.

## Can I install Slatted Cladding Panels on interior projects?

Yes, our Slatted Cladding can be used on indoor projects, providing the structural integrity of the wall can support the weight of the batten system as well as the Cladding Panels.



**Head Office**

Beardown Road  
Exeter Road Industrial Estate  
Okehampton  
Devon  
EX20 1UA

01837 659901

[info@cladco.co.uk](mailto:info@cladco.co.uk)

[www.cladcodecking.co.uk](http://www.cladcodecking.co.uk)

**CLADCO**  
DECKING